

**INPUT CHARACTERISTICS :**

- ◎ VOLTAGE : 100~240V, (Active PFC / Full Range)
- ◎ FREQUENCY : 47~63Hz ,
- ◎ POWER FACTOR CORRECTION: 0.99
- ◎ INPUT CURRENT : 14A
- ◎ INRUSH CURRENT : 65A/125A MAX FOR 115/230

**OUTPUT CHARACTERISTICS :**

OUTPUT VOLTAGE	OUTPUT CURRENT		REGULATION		OUTPUT
	MIN ( A )	MAX ( A )	LOAD	LINE	RIPPLE & NOISE MAX. [ P-P ]
+5V	0.2	35	±5%	±1%	60mV
+12V1	2	16	±5%	±1%	120mV
+12V2	0	16	±5%	±1%	120mV
+12V3	0	16	±5%	±1%	120mV
+12V4	0	16	±5%	±1%	120mV
-5V	0	0.8	±10%	±1%	120mV
-12V	0	1	±10%	±1%	120mV
+3.3V	0.5	30	±5%	±1%	60mV
+5VSB	0	3	±5%	±1%	60mV

The combined output power +5V&+3.3V shall not exceed 64A.

The combined output power +5V & +12V & +3.3V maximum output 980W.

The total power shall not exceed 1000W.

**SPECIFICATION :**

- ◎ TEMPERATURE RANGE : Operation 0°C ~ 50°C
- ◎ HOLD UP TIME : 16ms at maximum load & normal input voltage
- ◎ EFFICIENCY : 70% TYPICAL ( Normal Line )
- ◎ POWER GOOD SIGNAL : Should be asserted high to indicate that +5VDC and +3.3VDC output are above the low voltage thresholds. Compatible signal out with 100ms to 500ms.
- ◎ OVER POWER PROTECTION : The power supply shall shut down output power exceeds 130% to 160%
- ◎ OVER VOLTAGE PROTECTION : Standard on +5.0V, set at 6.25VDC ± 0.75VDC
- ◎ SHORT CIRCUIT PROTECTION : A short circuit placed between the DC return and the output shall cause no damage and the power supply shall shutdown.
- ◎ EMI : FCC part 15, subpart B, Class B, EN55022 CISPR22 Class B.
- ◎ AGENCY APPROVALS : UL60950, CAN/CSA22.2 No.60950, TUV(IEC60950)
- ◎ MEET EN-61000-3-2 CLASS D (ACTIVE PFC)
- ◎ REMOTE ON/OFF CONTROL : When PS-ON is pulled to TTL Low, the DC output is to be enabled, When PS-OFF is pulled to TTL high, the DC output is to be disabled.
- ◎ COLLING : By forced air 2x80mm Fan
- ◎ DIMENSION : L220 X W150 X H86 mm

REVISIONS		
REV	DESCRIPTION	DATE

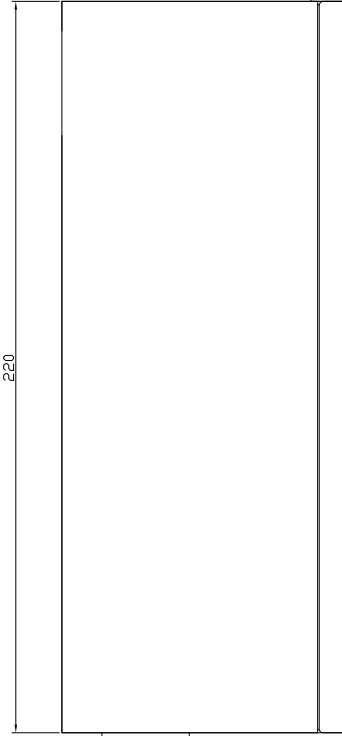
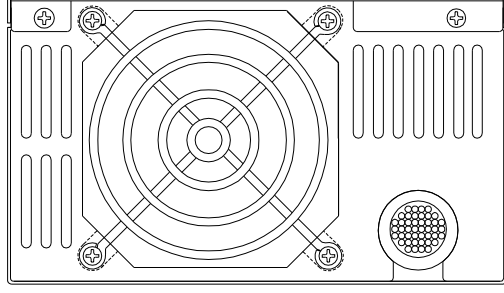
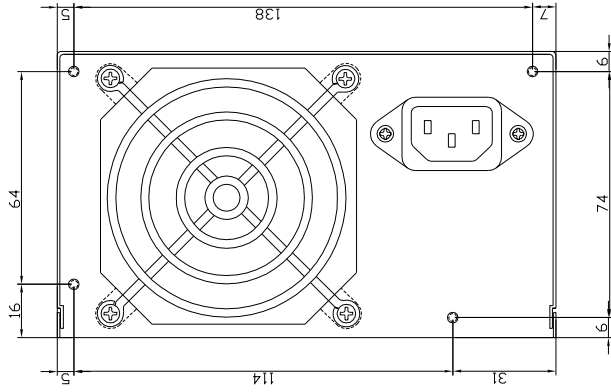
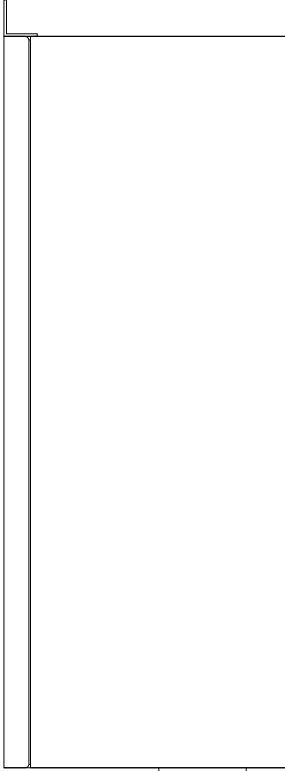

TOLEANCES	MATERIAL	UNIT	PART NO
X= +/- 0.25	REMARK	SCLAE	MODEL
.XX= +/- 0.100	APPD	DWG NO.	NAME
		CKD	DRAWN
		SHEET	
		DATE	

**TC-xxxPL**  
I-STAR  
COMPUTER



# PINOUPS OF CONNECTORS

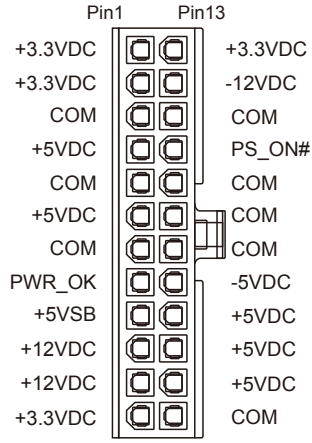

Main Power Connector

- +12V = yellow
- +5V = red
- +3.3V = purple
- +5VSB = brown
- PS\_ON# = gray
- PWR\_OK = orange
- 5V = white
- 12V = blue
- COM = black

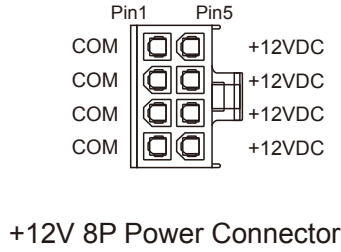

+12V 8P Power Connector

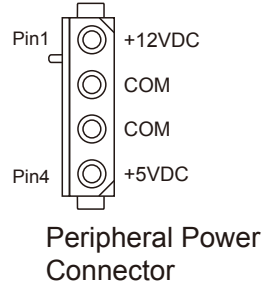

Peripheral Power Connector

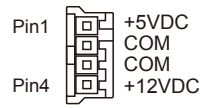

Floppy Drive Power Connector

X2

